

TECBL-440

Thermo-Electrically Cooled Blue Lasers



Specifications

OPTICAL

Wavelength	440 nm
Optical Output Power	5-40 mW
Laser Power Stability	< 0.5%
Laser Structure	Single Mode
Laser RMS Noise	< 0.5%
Polarization Ratio	> 100:1
Beam Size	3 mm (collimated)
Divergence (full)	< 0.5mrad
Beam Pointing Stability	< $\pm 10 \mu\text{rad}$
Warm-Up time	< 1 min

ELECTRICAL

Operating Voltage	3.3 V DC
Operating Current	< 1 A

MECHANICAL

Dimension	1" (Dia) x 3" (L)
Operating Temperature	+10°C to +40°C
Storage Temperature	-40°C to +80°C
Heat Sink Requirements	Recommended for extended use

TECBL-Series Laser Product Features

- Integrated TEC and Laser Controller
- Low RMS Noise
- Excellent Power & Wavelength Stability
- Compact Size
- Long Life-Time & Low Power Consumption

TECBL-Series Laser Applications

- Bioanalytical
- Measurement
- Confocal Microscopy

TECBL-Series Thermo-Electrically Cooled Blue Laser is a compact self-contained, highly reliable laser operating at very stable wavelength and power. The build-in temperature controller stabilizes the laser temperature within $\pm 0.01^\circ\text{C}$. The laser output power stability is better than 1% over long term. Extremely stable power, low noise and excellent beam pointing stability of this laser makes it ideal for bioanalytical, measurement and imaging applications. It is powered by a wall mount power adaptor (supplied with the laser) for plug & play operation.

TECBL-Series lasers can be customized to include beam shaping optics and modulation.

Operational Hazard-Semiconductor Laser Diode Module: This laser module emits radiation that is visible and harmful to human eye. When in use, do not look directly into the laser emitting aperture. Direct viewing of laser diode emission at close range may cause eye damage.

Limited Warranty: One year. No warranty coverage for disassembly, modifications or damage due to abuse or misapplication.

World Star Tech

sales@worldstartech.com

321 Lesmill Rd. Toronto, ON, M3B 2V1 Canada

www.worldstartech.com

info@worldstartech.com

Tel: (416) 363-3332 Fax: (416) 363-3112

TECBL-440

Thermo-Electrically Cooled Blue Laser Modules :Mechanical Dimensions

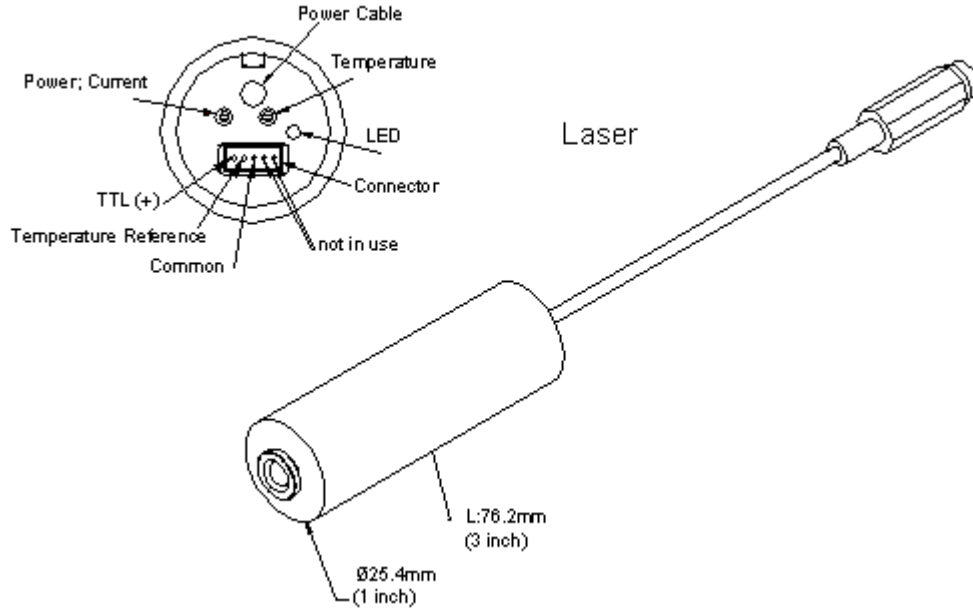

TECBL-Series Laser Ordering Information

Part# TECBL-pppG(c)-λλλ

Option	Meaning	Values
ppp	Laser output power (mW)	10 to 50mW
(c)	Circular laser diode beam (optional)	C (max power 25 mW with circular beam)
λλλ	Wavelength (nm)	440 +/-10 nm
TTL	TTL Modulation	Max 3KHz

Example Part Number :TECBL-5GC-440 (5mW, 440 nm, circular beam)



Class IIIB Modules sold solely for use in OEM equipment; OEM is responsible for compliance with all safety regulations.

World Star Tech

sales@worldstartech.com

info@worldstartech.com

321 Lesmill Rd. Toronto, ON, M3B 2V1 Canada

Tel: (416) 363-3332 Fax: (416) 363-3112

www.worldstartech.com